



Flight Light Inc.
2708 47th Ave.
Sacramento, California, U.S.A.
95822-3806

PH (916) 394-2800 FX (916) 394-2809
TF (800) 806-3548 EM info@flightlight.com

ZA163
Runway Edge Light

Compliance and Applications

FAA AC 150/5345-46 L-860, L-861, L-862

ICAO Annex 14, fig A2-9 and A2-10

CAA CAP168, fig 6A/9, 6A/10 & Table 6A/1

NATO STANAG 3316

BS3224 Part 4, elevated fittings

High intensity, bi-directional (with omni-directional component), elevated runway edge light for use in all weather operation installations up to ICAO category III systems.

Medium intensity, bi/uni-directional elevated threshold/end light.

Features

- Choice of three mounting options:
 - M32 threaded frangible (male threads)
 - 25mm I/D (female threads) with side cable entry
 - 25mm O/D (male threads) suitable for an FAA type frangible coupling
- Medium intensity, bi/uni-directional elevated threshold/end light.
- Outer glass dome molded in low expansion glass to resist thermal shock.
- Smooth outer glass surface resists build up of dirt and provides for easier cleaning.
- All sub-assemblies are keyed to simplify routine maintenance and ensure correct alignment.
- Robust corrosion resistant aluminum construction for strength and durability.
- Gimble mounting for ease of alignment and leveling.
- Screws are stainless steel.



- Silicon rubber gaskets seal the dome against ingress of liquids.
- Powder coat paint finish in golden yellow. All fasteners are stainless steel.
- IMM available on request.

Options

- ZS022 sighting device (SLC30035) with adapter (SLC30038)
- J1/80 Pk30d 100W (SLC08057)
- J1/83 Pk30d 150W (SLC08088)
- J1/84 Pk30d 200W (SLC08089)
- 180° colored glass filters:
 - Red (SLC19076)
 - Yellow (SLC19108)
 - Green (SLC19030)
 - Blue (SLC19132)

- 180° blanking screen (SLC26010)
- Daylight marker cone kit.

Electrical Supply

Suitable for use in 6.6A airfield lighting circuits, normally supplied from either a 45W, 100W, 150W or 200W series circuit isolating transformer. Power consumption varies depending upon type of lamp fitted.

Packaging Data

Net weight	3.97 lb. (1.8kg)
Gross weight	4.4 lb. (2.0kg)
Carton size	8.27" (210mm)(w) x 8.27" (210mm)(d) x 6.3" (160mm)(h)

Visit our web site: www.flightlight.com



Flight Light Inc.
 2708 47th Ave.
 Sacramento, California, U.S.A.
 95822-3806

PH (916) 394-2800
TF (800) 806-3548

FX (916) 394-2809
EM info@flightlight.com

ZA163 Runway Edge Light

Components

1	Marker cone (1-off)	29215
2	Rim (1-off)	SLC29214
3	Glass dome "O" ring (1-off)	SLC33091
4	Glass dome (1-off)	SLC16056
5	Filter glass various colors (1 or 2-off) See optional extras	
6	Filter clip (4 off)	29219
7	Lens holder (2-off)	29210
8	Lens (2-off)	27923
9	Top casting (1-off)	29211
10	J1/80 Pk30d 100W or J1/83 Pk30d 150W or J1/84 Pk30d 200W	SLC08057 SLC08088 SLC08089
11	Lamp retaining spring (1-off)	29216
12	Base casting "O" ring (1-off)	SLC33091
13	Lock spring (1-off)	29217
14	Base casting (1-off)	Not Saleable
15	Short lead for 1" O/D stem	
16	B type lead for 1" I/D and M32 stem	SLC13001
17	M20 elkay gland set and seal (1-off)	
18	1" O/D stem	29223
19	1" I/D stem	29222
20	M32 stem	29221
21	Clamp (1-off)	29213
22	M32 hexagonal nut (2-off)	
23	32 dia washer (2-off)	
24	Top Terminal Block Assy	
25	Base Terminal Block Assy	

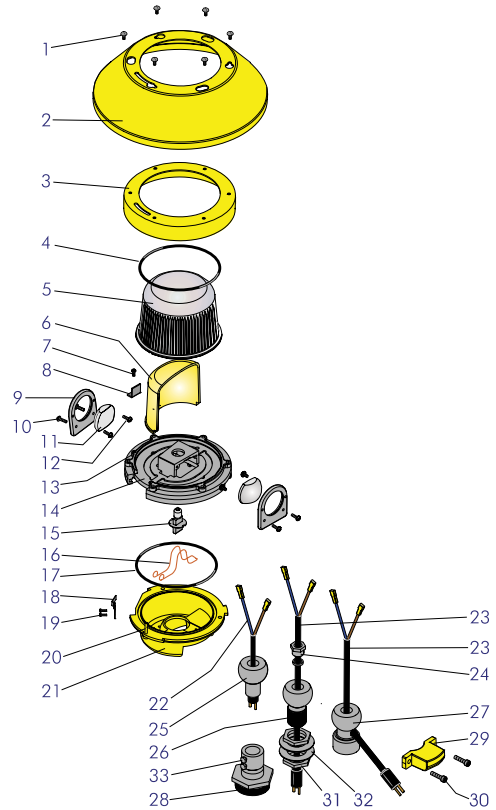

Typical Installation Methods

- On a 8" (204mm) diameter ground mounting plate
- On a FAA L867 type base can
- On a ground mounting spike
- On a FAA type frangible coupling
- Other installation methods available on request

ZA163 installed on 204mm (8") ground mounting plate

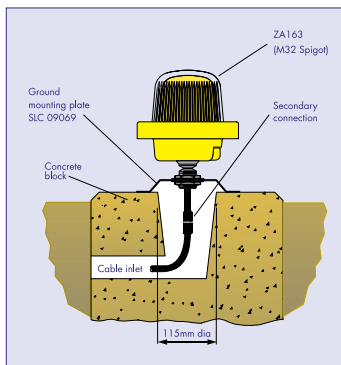

Note
 The ground mounting plate is designed to be held down by means of three 10mm (3/8") rag bolts grouted into the concrete block on 178mm PCD

ZA163 installed on a FAA L867 base can

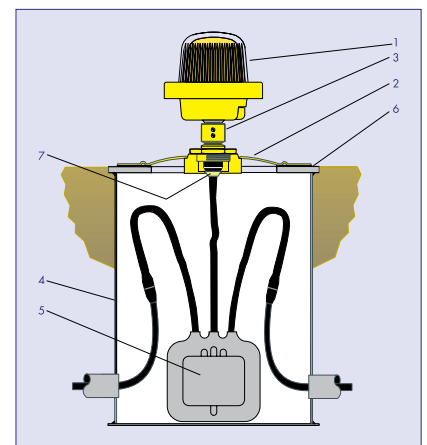

- | | | | |
|----|-------------------------|----|-----------------------|
| 1. | ZA163 25mm O/D Spigot | 5. | Isolating transformer |
| 2. | FAA Type L867 Baseplate | 6. | Gasket |
| 3. | Frangible Coupling | 7. | Support Plate |
| 4. | FAA Type L867 Base | | |

Visit our web site: www.flightlight.com



Flight Light Inc.
 2708 47th Ave.
 Sacramento, California, U.S.A.
 95822-3806

PH (916) 394-2800 FX (916) 394-2809
 TF (800) 806-3548 EM info@flightlight.com

ZA163 Runway Edge Light

ZA163 installed on a FAA Type frangible coupling

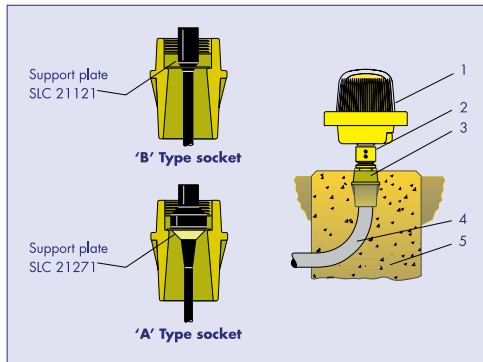

Alternative support arrangements for 'A' or 'B' type socket leads mounted in a wells coupling

- | | |
|--------------------------|--------------------------------------|
| 1. ZA163 25mm O/D Spigot | 4. 50mm dia. pipe (plastic or metal) |
| 2. Frangible coupling | 5. Concrete block |
| 3. Wells coupling | |

ZA163 installed on a short approach pole up to 2.2m long

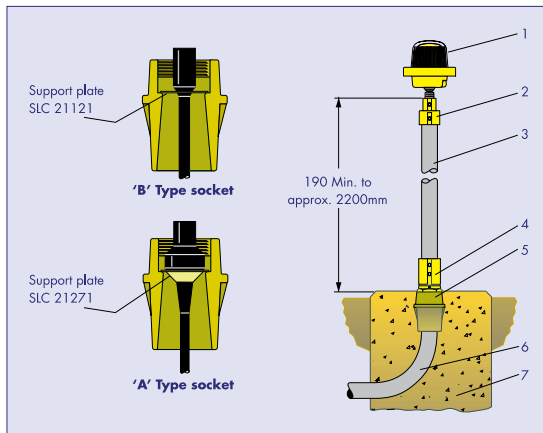

Alternative support arrangements for 'A' or 'B' type socket leads mounted in a wells coupling

- | | |
|---------------------------------|-------------------|
| 1. ZA163 M32 Spigot | 5. Wells Coupling |
| 2. Top Coupling | 6. 50mm dia. pipe |
| 3. Aluminum Tube 50.8 O/D 10SWG | 7. Concrete block |
| 4. Frangible coupling | |

ZA163 general arrangement

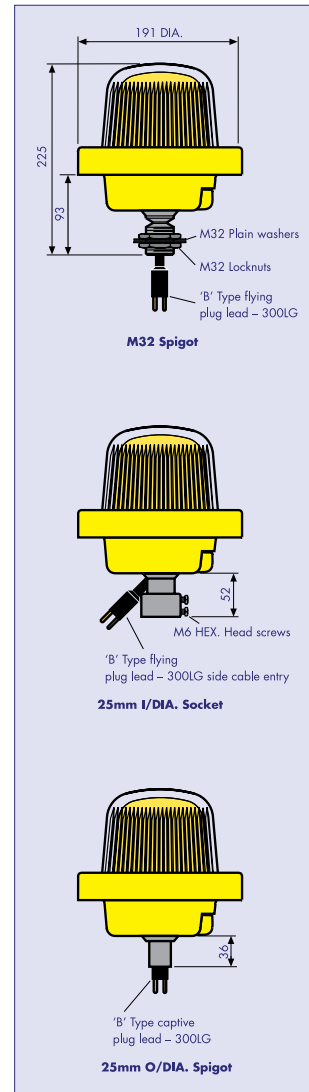

Visit our web site: www.flightlight.com



Flight Light Inc.
 2708 47th Ave.
 Sacramento, California, U.S.A.
 95822-3806

PH (916) 394-2800 FX (916) 394-2809
 TF (800) 806-3548 EM info@flightlight.com

**ZA163
 Runway Edge Light**

Photometric Performance

Runway Edge

White ZA163
 Main Ellipse Intensity Measurements (Candelas)
 Average 12639
 Min. Average 10000
 Max (B) 17250
 Min (A) 6927

Nominal Lamp Details
 Power 150 Watts
 Current 6.6 Amps
 Type J1/83
 CAP168 6A.9
 ICAO 2-9

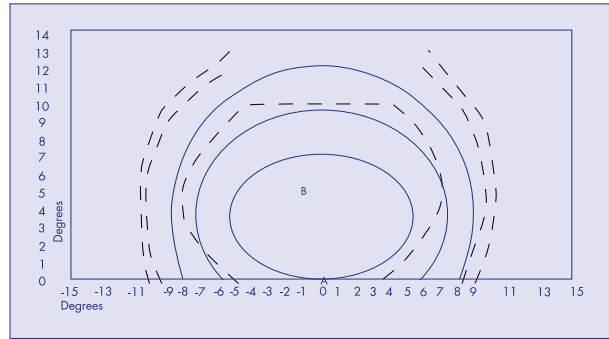

Runway Edge

White ZA163
 Main Ellipse Intensity Measurements (Candelas)
 Average 10916
 Min. Average 10000
 Max (B) 15058
 Min (A) 5785

Nominal Lamp Details
 Power 200 Watts
 Current 6.6 Amps
 Type J1/84
 CAP168 6A.10
 ICAO 2-10

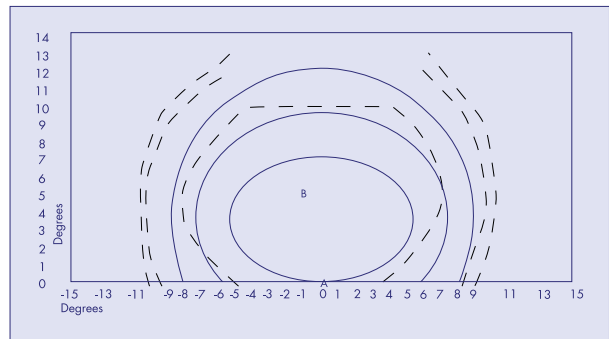

Other photometric information available on request.

	COLORS		LAMP	MOUNTING OPTIONS
ZA163	W	White	100	M32 25mm O/D 25mm I/D
	Y	Yellow	150	
	R	Red	200	
	G	Green		
	B	Blue		

Visit our web site: www.flightlight.com